

### Steuergeraet

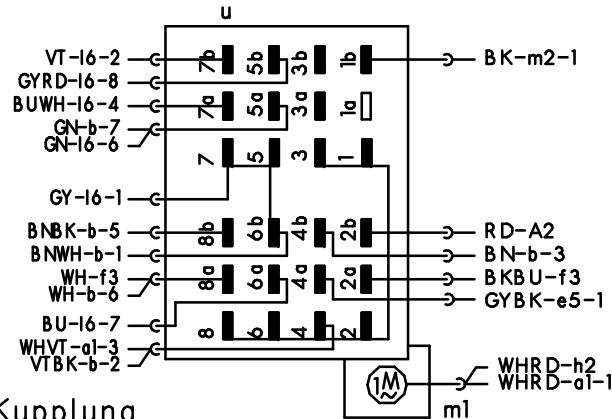

### Hauptschalter

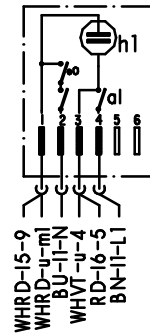

### Wahlschalter

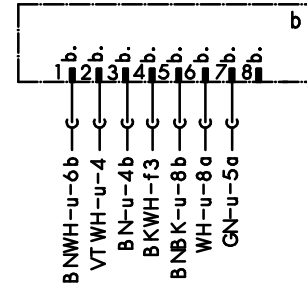

### Mangelanzeige

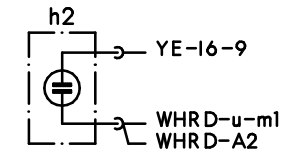

### Aktuator

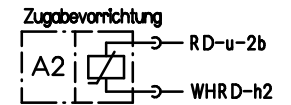

### Kupplung

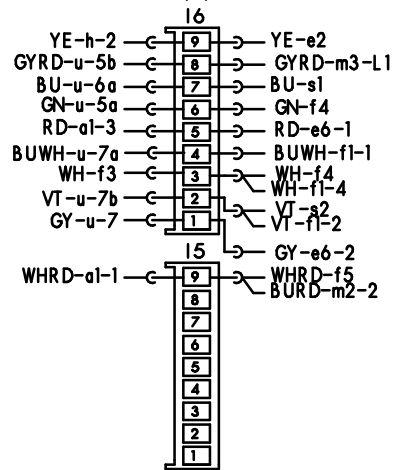

### Laugenpumpe

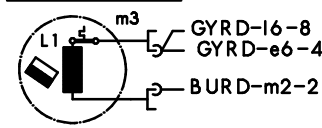

### Schwimmerschalter

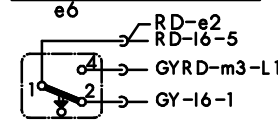

### Thermostat

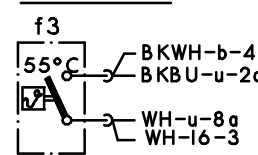

### Magnetventile

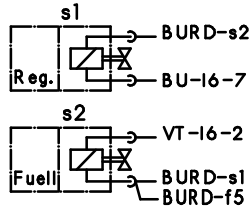

### Niveaudruckdose

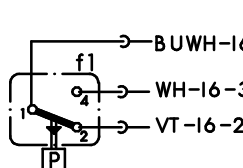

### Sicherheitsschalter

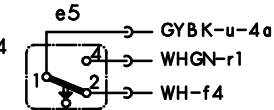

### Reedschalter

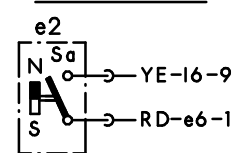

### PTC-Motor

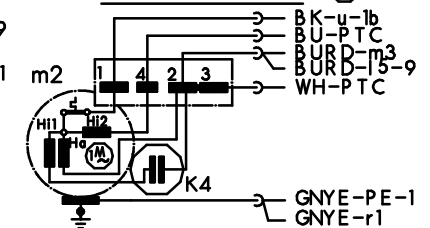

### Klemme II mit Entstoerung

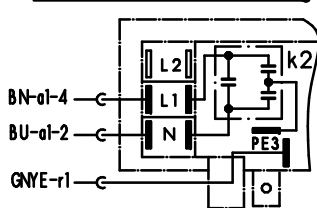

### Thermostat

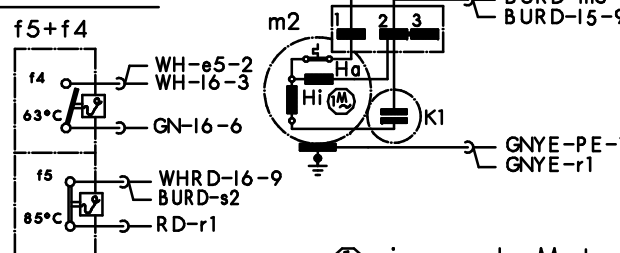

### Heizung

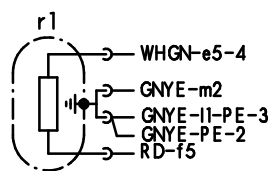

### Kondensatormotor

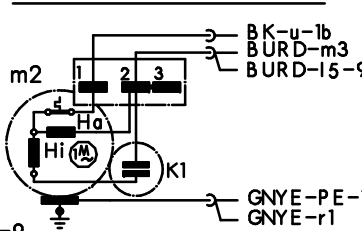

### Schutzleiter

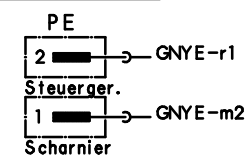

### AnlaB-PTC

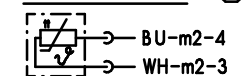

⊙ je nach Motortyp

1 739 911 131	
Ausg.: 03.97	S0-60/0332